

Afinia L301 from HD Labels Quick Setup & Installation Guide

For more detailed information, please refer to the **User Guide** installed on your PC.

Or contact **01264 335118** / info@hdlabels.co.uk for assistance.

Unpack:



1 Remove Tape



2 Connect Power

(a)

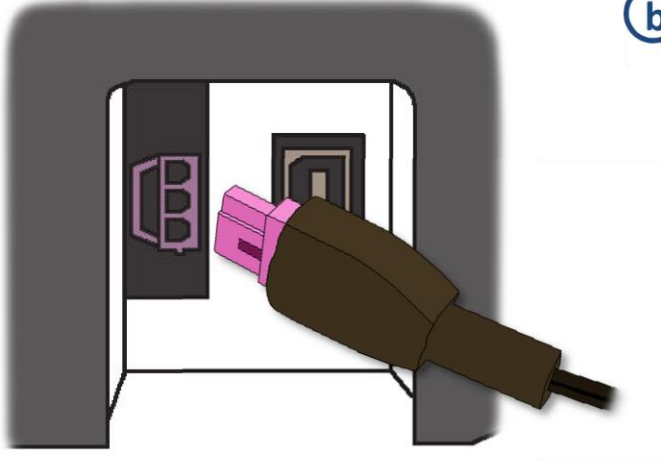

(b)



3 Install Ink Cartridges

(a) Open Ink Cartridge Access Door

(b) Remove plastic tape from cartridges using pull tab

(c) Lift cartridge latches

(d) Carefully insert ink cartridges
Must be Afinia ink cartridges!

(e) Lower cartridge latches until they click

(f) Close Ink Cartridge Access Door

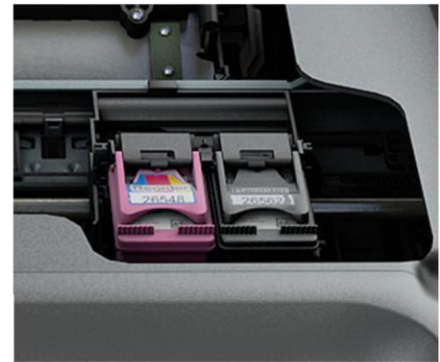

(c)



(d)



(e)

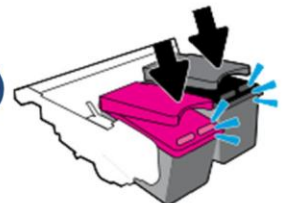

4 Install Printer

a



b

Run **Setup.exe**

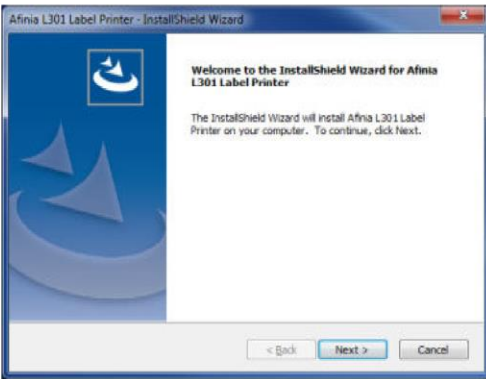

c

Click **Install** (will see this 3 times)



d

Connect printer to PC

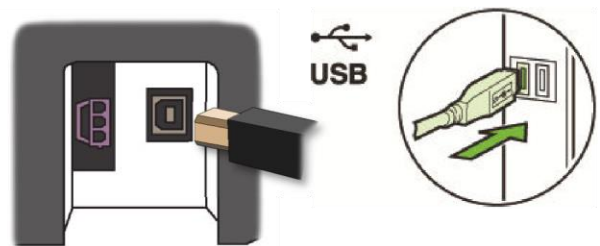

5 Install Unwinder and Load Media

a

Connect Unwinder to Printer

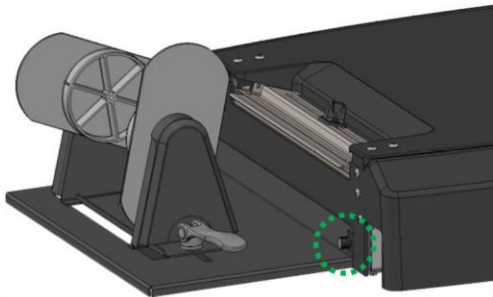

2 thumbscrews included for installation (1 shown)

b

Lift unwinder lever on adjustable holder to unlock

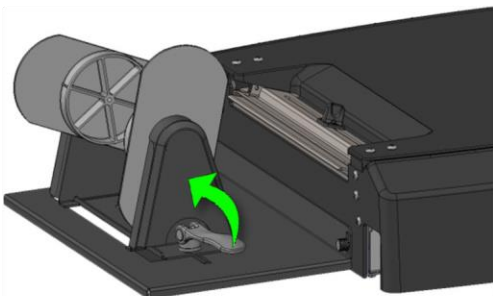

c

Place roll on fixed holder, slide adjustable holder onto core, lock lever down

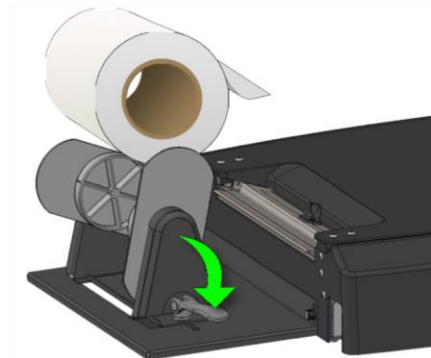

d

Insert stock into input slot

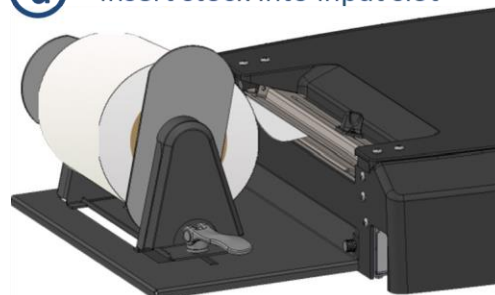

Push stock in until auto-feed begins, then adjust Paper Guide

Control Panel LEDs

The LEDs on the control panel indicate a number of printer states:

Green LED	Red LED	Display	
Off	Off	Off	1. Power cable not plugged in 2. Plugged in, but power button not pressed
Slow Blink	Fast Blink	Off	Power cable was just plugged in
Always On	Fast Blink	On	Printer powering up
Blink Slow	Off	On	Printer on, no stock loaded
Always On	Off	On	Printer on, stock loaded (ready)
On or Blink	Always On	On	Cutter not in Home position (fully left or right) <i>Printer is paused in this state</i>
On	Blink	“Printing...”, “Cancelling...”	Cut required. Perform cut and move cutter to home position
Fast Blink	Slow Blink	Incorrect Media	Cut and Unload media